

Cub Cadet [®]
COMMERCIAL
Operator's Manual
High Pressure Washer

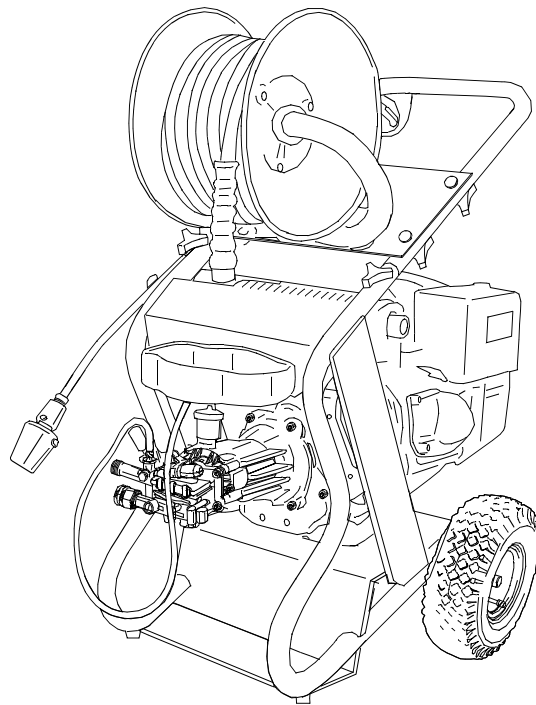

Model 3000C

IMPORTANT:
READ SAFETY RULES AND INSTRUCTIONS CAREFULLY
CUB CADET P.O. BOX 368023 CLEVELAND, OHIO 44136-9722 [www.cubcadet.com]

FORM NO. 770-10451
(9/00)

CONTENTS

Overview	3
Safe Operation Practices	3
Assembly Instructions	5
Operating Instructions	7
Using the Accessories	9
Working with Detergents	10
Shut Down and Clean-Up	11
Taking a Break	11
Winterizing and Long-Term Storage	12
Cleaning Tips	12
Optional Cleaning Accessories	13
Troubleshooting	14
Warranty	16

MODEL 2500C OVERVIEW

Specifications

Engine	10.0 HP Kohler Command
Water volume	3.0 GPM
Operating pressure	3000 PSI

Item Description

1. Water inlet
2. Detergent tray w/screw
3. Knob Assembly (six)
4. Oil fill cap (not seen)
5. High pressure hose
6. Detergent suction tube w/filter
7. Handle
8. Hose Reel Ass'y.
9. Trigger gun safety lock
10. Trigger gun
11. Pull start (not seen)
12. Gas tank
13. Throttle (not seen)
14. Choke (not seen)
15. Wand w/adjustable spray nozzle
16. High pressure outlet
17. Engine Air Cleaner
18. Pressure Control

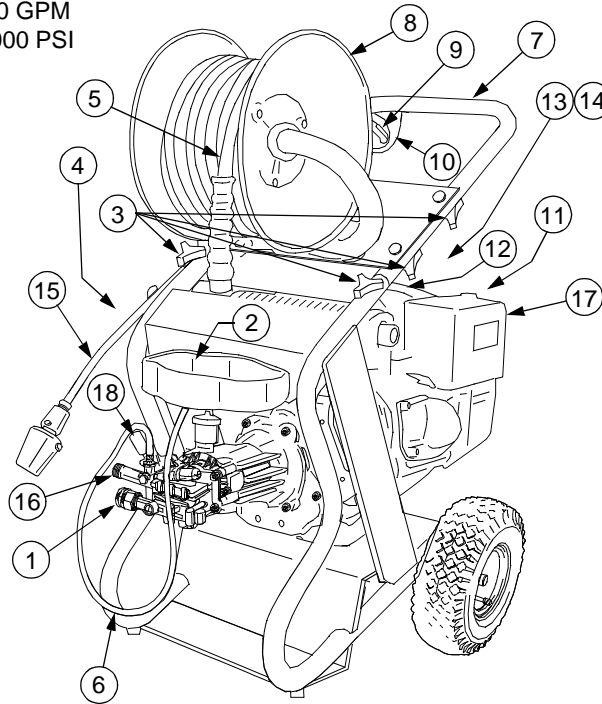

SAFE OPERATION PRACTICES — NEVER!

- Never** point nozzle at people or animals.
- Never** drink alcohol or use drugs while operating this equipment.
- Never** spray electrical connections, electrical outlets or fixtures.
- Never** add fuel with the engine running or operate where fuel has been spilled.
- Never** touch hot surfaces or allow accessories to contact hot surfaces.
- Never** operate in an enclosed space, exhaust fumes are dangerous.
- Never** operate near utilities with open flames.
- Never** operate without the water turned on and never use hot water.

SAFE OPERATION PRACTICES – Read First!



Safety Warnings

When using this product basic precautions should always be followed:

- Read all the instructions before using the product.
- **FIRE HAZARD!** Do not add fuel with the engine running. Do not operate if fuel has been spilled. Instead move the machine to a different location and avoid creating sparks.
- Operate and fuel machine in a well ventilated area, free of devices featuring an open pilot or flame such as boilers, water heaters, etc.
- High pressure jets can be dangerous if subject to misuse. The jet must not be directed at persons, animals, electrical devices or the machine itself.
- Wear safety goggles.
- Do not use acids, solvents, or any other flammable material in this product. These products can cause physical injuries to the operator and irreversible damage to the machine. If you have further questions regarding the use of recommended cleaning detergent, please call your Cub Cadet dealer.
- The machine has hot surfaces which can cause burns. Operate the unit in a safe environment and away from children.
- Do not allow the high pressure hose to come into contact with the muffler guard.
- Do not leave the machine running unattended.
- Learn how to stop the machine and release pressure quickly. Be thoroughly familiar with the controls.
- Stay alert — watch what you are doing.
- Do not operate the product when fatigued or under the influence of alcohol or drugs.
- Do not stand on unstable surfaces. Stand with both feet balanced at all times.
- The Gun Safety Lock PREVENTS the trigger from accidentally being engaged. This safety feature DOES NOT lock the trigger in the on position.

Water Supply (Cold Water Only)

- Water hose must be at least 3/4 inch in diameter.
- Flow rate of water supply must not fall below 2.5 GPM (gallons per minute).
- Flow rate can be determined by running the water for one minute into an empty 5-gallon container.
- The water supply temperature must not exceed 104°F/40°C.
- Never use the pressure washer to draw in water contaminated with solvents, e.g. paint thinners, gasoline, oil, etc.
- Always prevent debris from being drawn into the unit by using a clean water source.

We strongly recommend that this high pressure washer not be left running for periods of 5 minutes or longer without the trigger gun being engaged.

This high pressure washer is equipped with thermal protection to extend the life of your pressure washer. The thermal protector will automatically activate at a predetermined temperature ejecting hot water before resetting. This ensures that the pump does not become damaged.



Caution

- Follow the maintenance instructions specified in the manual.
- This machine has been designed for use with cleaning detergent supplied or recommended by the manufacturer. The use of other cleaning detergents may affect the operation of the machine and void the warranty.

ASSEMBLY INSTRUCTIONS

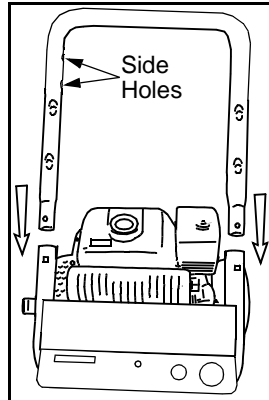

Step1 Standing at the rear of the unit (engine end), position the handle so that the side holes are to the right. Slide the handle into the frame.

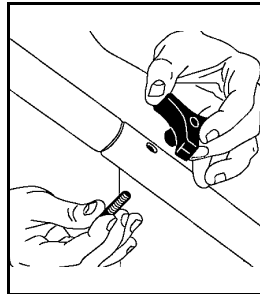

Step2 Align holes, insert bolt from bottom and tighten with knob from the top (both sides).

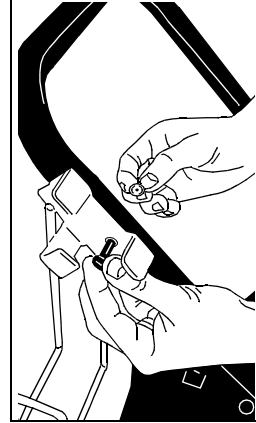

Step3 Position the hose & gun holder to align with the holes in the right side of the handle and fasten with two screws and nuts.

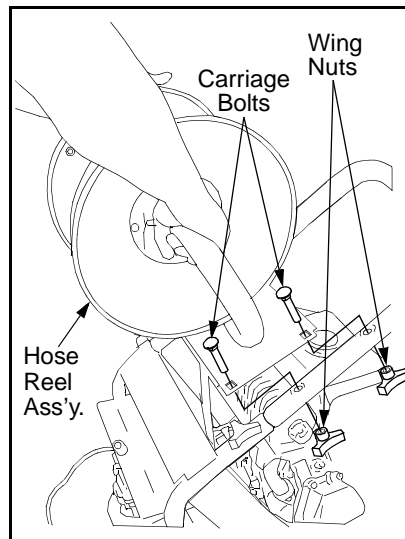

Step4 Route the hose of the reel ass'y. through the center of the handle and position the reel ass'y. to align with the four holes in the handle. Insert the four carriage bolts and secure with the wing nut knobs.

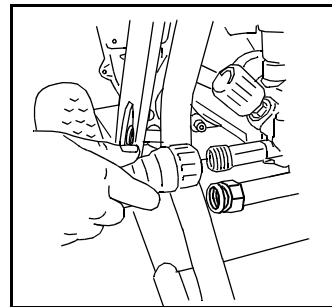

Step5 Connect the hose from the reel ass'y. to the high pressure outlet.

Step6 Follow the graphic instructions provided with the hose reel ass'y., to complete the following assembly steps:

- Install the Reel Ass'y. Handle
- Connect the High Pressure Hose to the fitting of the Reel Ass'y.
- Secure the High Pressurt Hose to the Reel Ass'y.

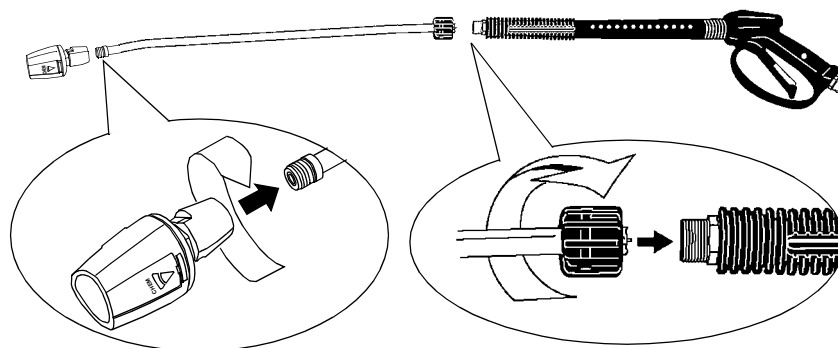

Step4 Attach the touch-less nozzle to the spray wand.

Step5 Attach the spray wand to the trigger gun.

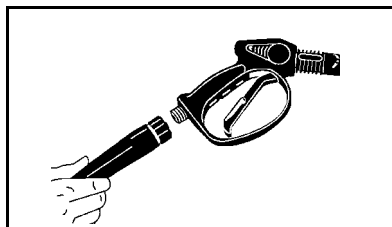

Step6 Attach the high pressure hose to the trigger gun.

OPERATING INSTRUCTIONS

Important! Do not run the engine with a high or low oil level as this can cause engine damage. If you have further questions regarding the engine, please refer to the engine's operating manual included with the unit.

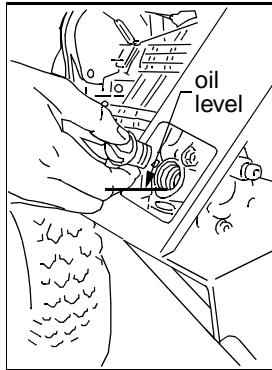

Step1 Check oil level. Oil level should be to the point of overflow on the oil filler neck. Be sure the machine is level when checking the oil level. (Refer to the engine's operating manual for seasonal grades.)

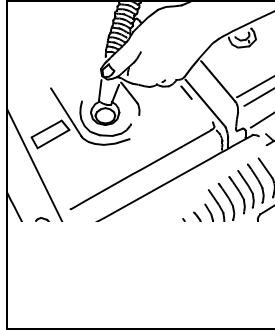

Step2 Fill gas tank with unleaded gasoline.

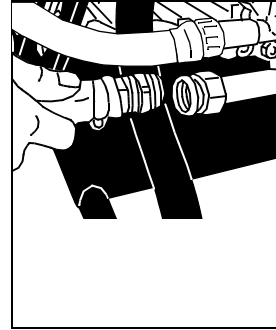

Step3 Connect garden hose to unit's water inlet.

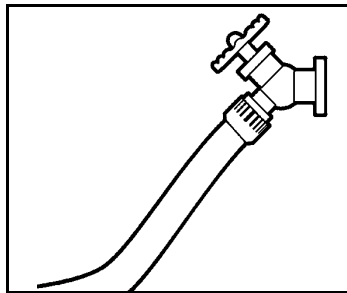

Step5 Connect garden hose to the cold water source and turn water on.

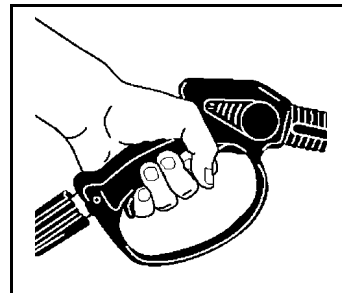

Step6 Trigger the gun to eliminate trapped air. Wait for a steady flow of water to emerge from the spray nozzle.

OPERATING INSTRUCTIONS - continued

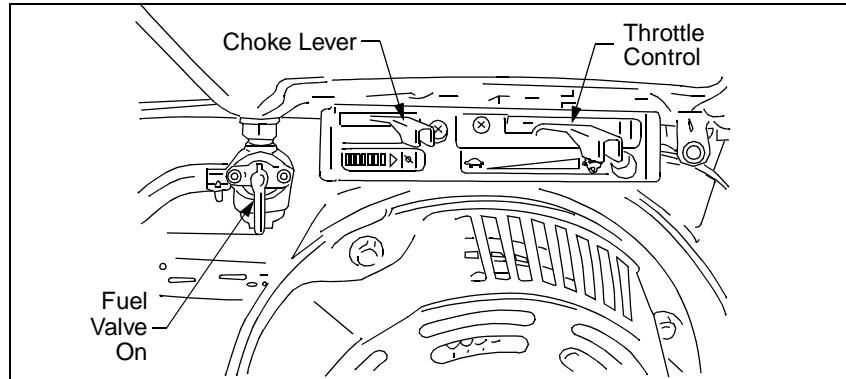

Step7 Turn the engine fuel shut-off valve to the "ON" position.

Step8 Move the choke lever to the "CLOSED" position (warm engine, leave the choke lever in the "OPEN" position.

Step9 Place the throttle control midway between the "SLOW" and "FAST" positions.

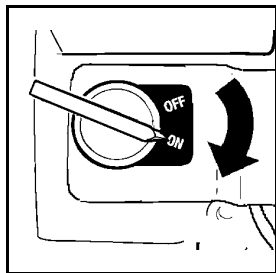

Step10 Turn the engine On/Off switch to the "On" position.

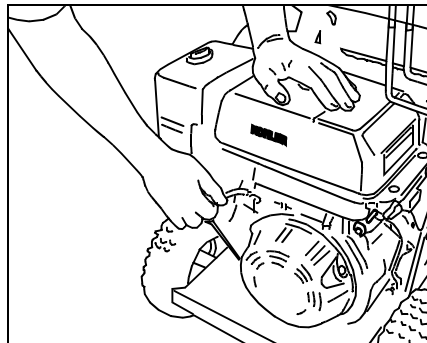

Step11 Pull the starter handle. If the engine fails to start after 3 pulls squeeze the trigger gun to release pressure, and repeat step 11.

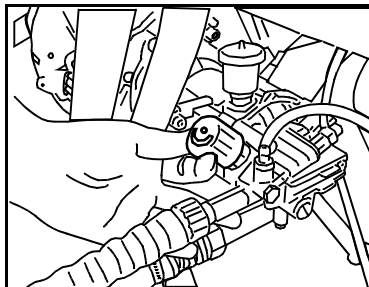

Step12 Adjust pressure control to desired setting.

USING THE ACCESSORIES

The touch-less nozzle is positioned in either the high pressure cleaning, or low pressure chemical, setting by turning the nozzle tip.

High Pressure Cleaning

Turn the nozzle tip to align the high pressure icons with the nozzle collar notch. The spray pattern is determined by the position of the nozzle's internal valve. To determine the spray pattern, point the gun in a safe direction and momentarily depress the trigger while observing the spray pattern. To change the spray pattern, rotate the gun barrel/spray wand approximately 60° to 90° to either the left or right and retest for spray pattern. If the spray pattern has not changed, return the gun barrel/wand to the original position; then rotate 60° to 90° in the opposite direction and retest. This should give you the alternate spray pattern. Once the valve position is set **and the gun trigger is depressed**, the spray pattern will be maintained regardless of the position of the gun barrel/spray wand.

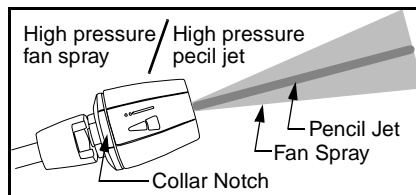

The pencil jet spray (0°) should be used for stubborn dirt

The high pressure fan spray (25°) should be used for cleaning over a large surface area.

Low Pressure Detergent Cleaning

Turn the nozzle tip to align the low pressure chemical icon with the nozzle collar notch.

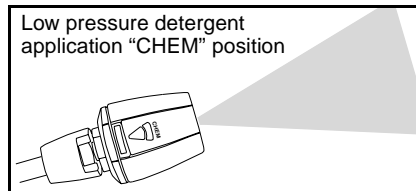

The low pressure chemical setting is used for the application of approved detergents.

Rotating Spray Nozzle

This nozzle features a 0° pencil jet which rotates 360° for maximum dirt cutting action, effectively increasing cleaning performance up to 50%. This nozzle combines the cleaning performance of a 0° pencil jet with the surface coverage of a wide angle nozzle. Not recommended for soft materials, siding, painted surfaces, decks or autos.

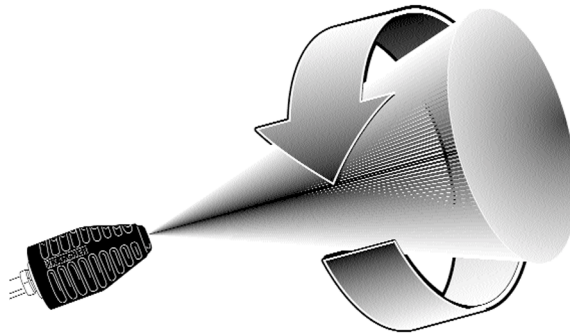

WARNING: TO AVOID SERIOUS INJURY, NEVER POINT SPRAY NOZZLE AT YOURSELF, OTHER PERSONS OR ANIMALS

WORKING WITH DETERGENT

Detergents can only be applied in the "low" setting.

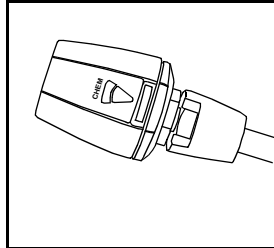

Step1 To apply detergents the touch-less nozzle must be set to the low pressure "CHEM" position.

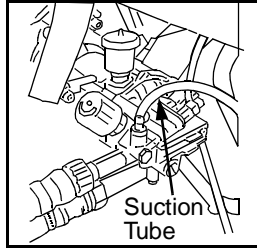

Step2 Connect the suction tube to the fitting on the pump

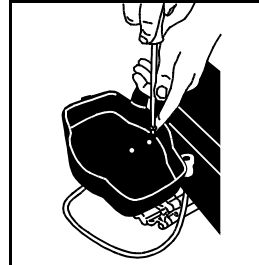

Step3 Slide the detergent tray into the frame slot. Secure the tray to the frame by fastening the screw.

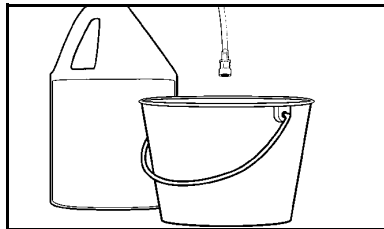

Step4 Fill a container with Cub Cadet detergent and place the container in the detergent tray. Place the filter end of detergent suction tube into the container. Be sure to adjust the filter by turning it to the desired detergent intake.

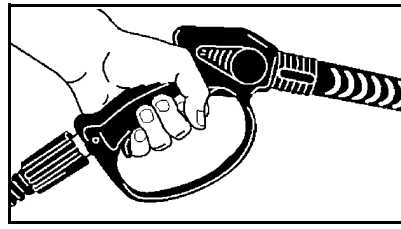

Step5 With the engine running, pull trigger to operate unit: Liquid detergent is drawn into the unit and mixed with water. Apply detergent to work area. Do not allow detergent to dry on surface.

For best results see Cleaning Tips on pages 12 & 13 for specific information on how to clean different surfaces.

Always Use Cub Cadet Detergents for Best Results.

Cub Cadet biodegradable detergents are specially formulated to protect the environment and your pressure washer. The special formulas will not clog the suction tube filter and will protect the internal parts of the pressure washer for a longer life. For Cub Cadet Detergents, check your local Cub Cadet dealer. If you need help locating a dealer in your area, contact the Customer Dealer Referral Line by calling:

1-877-835-7841

One gallon container of the following Cub Cadet detergents are available:

- Vehicle Wash Part No. KR-9103501
- Deck Wash Part No. KR-9103502
- Degreaser Part No. KR-9103503
- All Purpose Cleaner Part No. KR-9103504



Caution

Never use:

- Bleach, Chlorine products and other corrosive chemicals
- Liquids containing solvents (i.e., paint thinners, gasoline, oils)
- Tri-sodium phosphate products
- Ammonia products
- Acid-based products

These chemicals will harm the unit and will damage the surface being cleaned.

SHUTTING DOWN & CLEAN-UP

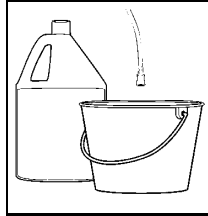

Step1 Remove detergent suction tube from container and insert into one gallon of fresh water. Siphon water at low pressure for one minute.

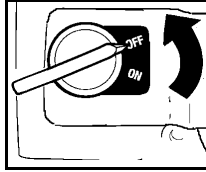

Step2 Move the throttle control lever to the "SLOW" position and allow engine to idle 30-60 seconds. Turn the engine on/off switch to the "OFF" position.

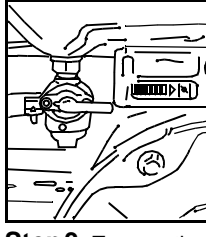

Step3 Turn the engine fuel shut-off valve to the "OFF" position

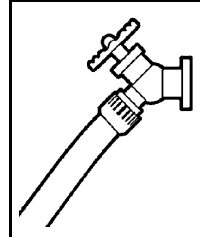

Step4 Turn off the water source.

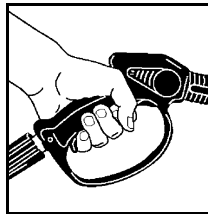

Step5 Press trigger to release water pressure.

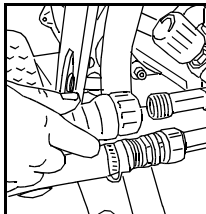

Step6 Disconnect the high pressure hose from the high pressure outlet.

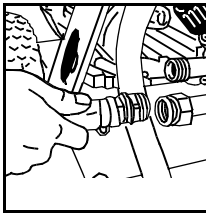

Step7 Disconnect the garden hose from the water inlet on the unit.

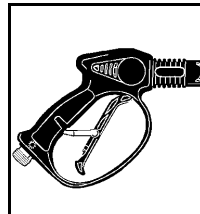

Step8 Engage the gun safety lock.

TAKING A BREAK... five minutes or more

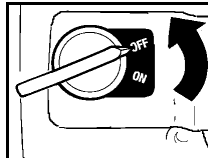

Step1 Move the throttle control lever to the "SLOW" position and allow engine to idle 30-60 seconds. Turn the engine on/off switch to the "OFF" position.

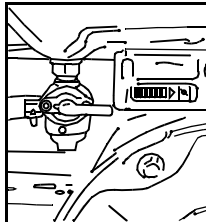

Step2 Turn the engine fuel shut-off valve to the "OFF" position

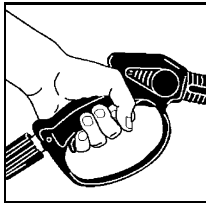

Step3 Press trigger to release water pressure.

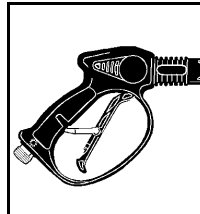

Step4 Engage the gun safety lock.

WINTERIZING AND LONG-TERM STORAGE

1. Disconnect all water connections.
2. Start the machine for a few seconds, until the water which had remained in the pump exits. Turn off immediately.
3. Drain the gas and oil from the engine.
4. Do not allow high pressure hose to become kinked.
5. Store the machine and accessories in a room which does not reach freezing temperatures. The machine should not be placed near an open flame i.e. furnace, hot water heater etc.

Caution: Failure to follow the above directions will result in damage to the pump assembly and accessories.

CLEANING TIPS

Deck Cleaning

(with or without detergent)

Pre-rinse deck and surrounding area with fresh water. If using Cub Cadet Deck Wash, place detergent suction tube directly into cleaning solution and apply to surface at low pressure. For best results, limit your work area to smaller sections of approximately 25 square feet. Allow Cub Cadet Deck Wash to remain on surface 1-3 minutes. Do not allow detergent to dry on surface. Rinse at high pressure in a long sweeping motion keeping the spray nozzle approximately 6 inches from the cleaning surface. Always clean from top to bottom and from left to right. When moving on to a new section of the cleaning surface, be sure to overlap the previous section to eliminate stop marks and ensure a more even cleaning result.

Caution: Do not use rotating nozzle spray wand on wood surface as it may cause damage.

House Siding

(with or without detergent)

Pre-rinse cleaning surface with fresh water. If using Cub Cadet All Purpose Cleaner, place detergent suction tube directly into cleaning solution and apply to surface at low pressure (for best results, limit your work area to sections of approximately 6 feet and always apply detergent from bottom to top). Allow Cub Cadet All Purpose Cleaner to remain on surface 1-3 minutes. Do not allow detergent to dry on surface, if surface appears to be drying, simply wet down surface with fresh water. Rinse at high pressure from top to bottom in an even sweeping motion keeping the spray nozzle approximately 6 inches from the cleaning surface.

Caution: Do not use rotating nozzle spray wand on siding as it may cause damage.

Cement Patios,

Brick and Stone

(with or without detergent)

Pre-rinse cleaning surface with fresh water. If using Cub Cadet All Purpose Cleaner, place detergent suction tube directly into cleaning solution and apply to surface at low pressure. For best results, limit your work area to smaller sections of approximately 25 square feet. Allow Cub Cadet All Purpose Cleaner to remain on surface 1-3 minutes. Do not allow detergent to dry on surface. Rinse at high pressure in a sweeping motion keeping the spray nozzle approximately 3-6 inches from the cleaning surface. Always clean from top to bottom and from left to right.

For removing extremely stubborn stains, use the Cub Cadet Rotating Nozzle Spray Wand.

Cars, Boats & Motorcycles

(with or without detergent)

Pre-rinse vehicle with fresh water. If using Cub Cadet Vehicle Wash, place detergent suction tube directly into cleaning solution and apply to surface at low pressure. For best results, clean one side of vehicle at a time and always apply detergent from bottom to top, do not allow detergent to dry on surface. Rinse at high pressure in a sweeping motion keeping the spray nozzle approximately 8 inches from the cleaning surface (distance should increase when rinsing pin-striping or other sensitive surfaces). Always clean from top to bottom and from left to right. For best results, wipe surface dry with a chamois or soft dry cloth.

Caution: Do not use rotating nozzle spray wand on vehicles as it may cause damage.

CLEANING TIPS - continued

Barbecue Grills, Outdoor Power Equipment & Gardening Tools

(with or without detergent)

Pre-rinse cleaning surface with fresh water. If using Cub Cadet All Purpose Cleaner or Degreaser, place detergent suction tube directly into cleaning solution and apply detergent at low pressure. Allow Cub Cadet detergent to remain on surface 1-3 minutes. Do not allow detergent to dry on surface. Rinse at high pressure keeping the spray nozzle approximately 6 inches from the cleaning surface. For removing extremely stubborn dirt, it may be necessary to move the spray nozzle even closer to the surface for greater dirt cutting action. To remove caked on mud from garbage cans, lawn mower blades, wheel barrels or other non-sensitive metal surfaces, you may want to use the Cub Cadet Rotating Nozzle Spray Wand.

Caution: Do not use rotating nozzle spray wand on cloth, plastic or other sensitive surfaces as it may cause damage.

Patio & Lawn Furniture

(with or without detergent)

Pre-rinse furniture and surrounding area with fresh water. If using Cub Cadet All Purpose Cleaner, place detergent suction tube directly into cleaning solution and apply to surface at low pressure. Allow Cub Cadet All Purpose Cleaner to remain on surface 1-3 minutes. Do not allow detergent to dry on surface. Rinse at high pressure in a sweeping motion keeping the spray nozzle approximately 6 inches from the cleaning surface. For best results, clean from top to bottom and from left to right. Caution: Do not use rotating nozzle spray wand on patio or lawn furniture as it may cause damage.

Recommendations

- Before cleaning any surface an inconspicuous area should be cleaned to test spray pattern and distance for maximum cleaning results.
- If painted surfaces are peeling or chipping, use extreme caution as pressure washer may remove the loose paint from the surface.

Use extreme caution when cleaning decks, siding, and other sensitive surfaces as the pencil jet may cause damage if not used correctly.

OPTIONAL CLEANING ACCESSORIES

To further enhance your cleaning capabilities, optional cleaning accessories are available from your local Cub Cadet dealer:

- | | |
|-------------------------------|---------------------|
| • Rotating Nozzle - Pro | Part No. KR-9103403 |
| • 30 Ft. Extension Hose - Pro | Part No. KR-9103007 |
| • Hose Reel/Steel - Pro | Part No. KR-9103054 |
| • Water Filter - Pro | Part No. KR-9103151 |

If you need help locating a dealer in your area, contact the Customer Dealer Referral Line by calling:

1-877-835-7841

TROUBLESHOOTING

Symptom	Cause	Solution
Engine will not start For additional engine problems refer to the engine owners manual.	No gasoline.	Fill gas tank.
	Low oil level.	Add oil.
	Choke is not in correct position.	Slide choke lever to "CHOKE" position.
	Engine throttle is not in correct position.	Position the throttle to "FAST".
	Pressure built up in the high pressure washer.	Squeeze the trigger to release the pressure.
	The fuel valve not in the right position.	Turn the fuel valve "ON".
	The engine switch is not in the correct position	Turn the engine switch "ON".
Unit does not reach high pressure.	Diameter of garden hose is too small.	Replace with a 3/4 inch garden hose.
	Water supply is restricted.	Check garden hose for kinks, leaks and blockage.
	Not enough inlet water supply	Open water source full force.
	Water inlet filter is clogged.	Remove filter and rinse out in warm water.
	Spray nozzle is in low pressure "CHEM" position.	Turn spray nozzle tip to high pressure position.
Output pressure varies high and low.	Not enough inlet water supply.	Turn water on full force. Check garden hose for kinks, leaks or blockage.
	Pump is sucking air.	Check that hoses and fittings are air tight. Turn off machine and purge pump by squeezing trigger gun until a steady flow of water emerges through the nozzle.
	Water inlet filter is clogged.	Remove filter and rinse out in warm water.
	Discharge nozzle is obstructed.	Blow out or remove debris with a fine needle.
	Calcified gun, hose or spray wand.	Run distilled vinegar through detergent suction tube.

TROUBLESHOOTING - continued

Symptom	Cause	Solution
No detergent.	Detergent suction tube not properly connected to the machine.	Check connection.
	Detergent is too thick.	Dilute detergent, for best results use Cub Cadet detergent.
	The filter is closed.	Open the filter by turning it to the desired detergent intake.
	Filter on detergent suction tube is clogged.	Run warm water through filter to remove debris.
	Damaged or clogged detergent suction tube.	Remove obstruction or replace detergent suction tube.
	Spray nozzle is in high pressure position.	Turn spray nozzle tip to low pressure position.
	Discharge nozzle is obstructed.	Blow out or remove debris with a fine needle.
Garden hose connection leaks.	Loose fittings.	Tighten fittings.
	Missing/worn rubber washer.	Insert new washer.
Touch-less nozzle or Spray wand leaks.	Nozzle or spray wand not properly attached.	Tighten connections.
	Broken o-ring or plastic insert.	Contact your local Cub Cadet dealer.
Pump is noisy.	Pump is sucking air.	Check that hoses and fittings are air tight. Turn off machine and purge pump by squeezing trigger gun until a steady flow of water emerges through the nozzle.
Water leaks from pump (up to 10 drops per minute is permissible).	Loose fittings.	Check that all fittings are tight.
	Thermal protection device has been activated.	Thermal protection device will automatically reset.
	Water seals are damaged or worn.	Contact your local Cub Cadet dealer.
Oil Drip.	Oil seals are damaged or worn.	Contact your local Cub Cadet dealer.

- If you encounter any additional difficulties not listed, please contact your local Cub Cadet dealer.

Cub Cadet 
COMMERCIAL
MANUFACTURER'S LIMITED WARRANTY
for COMMERCIAL PRESSURE WASHERS
(COMMERCIAL LINE)

The limited warranty set forth below is given by CUB CADET COMMERCIAL with respect to new merchandise purchased and used in the United States, its possessions and territories.

CUB CADET COMMERCIAL warrants this product against defects in material and workmanship for a period of **two (2) years** for commercial users, commencing on the date of original purchase and will, at its option, repair or replace, free of charge, any part found to be defective in material or workmanship. This limited warranty shall only apply if this product has been operated and maintained in accordance with the Operator's Manual furnished with the product, and has not been subject to misuse, abuse, neglect, accident, improper maintenance, improper storage or handling, freezing, use of improper chemicals, alterations, vandalism, theft, fire, water, or damage because of other peril or natural disaster. Damage resulting from the installation or use of any accessory or attachment not approved by Cub Cadet for use with the product(s) covered by this manual will void your warranty as to any resulting damages. The following parts and accessories are subject to separate terms as follows: Limited Warranty: 90-day free replacement for defects in materials and/or workmanship on hoses, hose reels, spray wands, brushes, nozzles and/or similar approved accessories.

HOW TO OBTAIN SERVICE: Warranty service is available, WITH PROOF OF PURCHASE, THROUGH YOUR LOCAL AUTHORIZED CUB CADET or CUB CADET COMMERCIAL DEALER. To locate the dealer in your area, please check for a listing in the Yellow Pages or contact CUB CADET by calling 877-835-7841 or writing to PO BOX 368023, Cleveland, Ohio 44136-9723.

This limited warranty does not provide coverage in the following cases:

- (a) Routine maintenance items such as lubricants, filters, tune-ups, or adjustments.
- (b) Equipment setup, normal wear parts or components.
- (c) CUB CADET COMMERCIAL does not extend any warranty for products sold or exported outside of the United States, its possessions, and territories.

No implied warranty, including any implied warranty of merchantability or fitness for a particular purpose, applies after the applicable period of express written warranty above. No other express warranty or guaranty, whether written or oral, except as mentioned above, given by any person or entity, including the dealer with respect to any product shall bind CUB CADET COMMERCIAL. During the period of the Warranty, the exclusive remedy is repair or replacement of the product as set forth above. (Some states do not allow limitations on how long an implied warranty lasts, so the above may not apply to you.)

The provisions as set forth in this Warranty provide the sole and exclusive remedy arising for the sale. CUB CADET COMMERCIAL shall not be liable for incidental or consequential loss or damages including, without limitation to, any claim for loss of profits, loss of savings or revenue, loss of the use of the equipment or any associated equipment, facilities or service, downtime, the claims or costs of third parties including customers, and injury to property, and further including expenses incurred for substitute or replacement property care services, for transportation or for related expenses, or for rental expenses to temporarily replace a warranted product. (Some states do not allow the exclusion or limitation of incidental or consequential damages, so the above exclusion may not apply to you.)

In no event shall recovery of any kind be greater than the amount of the purchase price of the product sold. Alteration of the safety features of the product shall void this warranty. You assume the risk and liability for loss, damage, or injury to you and your property and/ or to others and their property arising out of use or misuse or inability to use this product.

This limited warranty shall not extend to anyone other than the original purchaser or original lessee, or the person for whom it was purchased as a gift.

HOW STATE LAW RELATES to this WARRANTY: This limited warranty gives you specific legal rights, and you may also have other rights which vary from state to state.